



# User's Manual

## Upright Freezer

Before using your product, please read this manual carefully and keep it for future reference.

**MODEL: MUF-208SD**



## Contents

1.	SAFETY WARNINGS.....	1
2.	INSTALLTION.....	2
2.1	Location.....	2
2.2	Reversing the Door Swing.....	2
2.3	Door Space Requirements.....	6
2.4	Levelling the Unit.....	6
2.5	Cleaning Before Use.....	6
2.6	Before Using Your Unit.....	6
2.7	Interior Accessories.....	7
3.	PRODUCT OVERVIEW.....	7
4.	OPERATION.....	8
4.1	Switching On Your Unit.....	8
4.2	Noise Inside the Unit!.....	8
4.3	Tips for Keeping Food in the Unit.....	8
5.	CLEANING.....	9
5.1	Defrosting.....	9
5.2	Cleaning the Interior and the Exterior of the Unit.....	9
5.3	Cleaning Tips.....	9
6.	MAINTENANCE.....	9
6.1	Care When Handling / Moving Your Unit.....	9
6.2	Servicing.....	9
6.3	Switching Of for Long Periods of Time.....	9
7.	Trouble shooting.....	10
7.1	Warm tips:.....	10
8.	TIPS FOR ENERGY SAVING.....	10
9.	DISPOSAL.....	11

## 1. SAFETY WARNINGS

- 1) **WARNING**—Keep ventilation openings, in the appliance enclosure or in the built-in structure, clear of obstruction.
- 2) **WARNING**—Do not use mechanical devices or other means to accelerate the defrosting process, other than those recommended by the manufacturer.
- 3) **WARNING**—Do not damage the refrigerant circuit.
- 4) **WARNING**—Do not use electrical appliances inside the food storage compartments of the appliance, unless they are of the type recommended by the manufacturer.
- 5) The appliance has to be unplugged after use and before carrying out user maintenance on the appliance.
- 6) This appliance can be used by children aged from 8 years and above and persons with reduce physical sensory or mental capabilities or lack of experience and knowledge if they have been given supervision or instruction concerning use of the appliance in a safe way and understand the hazards involved. Children shall not play with the appliance. Cleaning and user maintenance shall not be made by children without supervision.
- 7) If the supply cord is damaged, it must be replaced by the manufacturer, its service agent or similarly qualified persons in order to avoid a hazard.
- 8) Please abandon the refrigerator according to local regulators for it use flammable blowing gas and refrigerant.
- 9) Please according to local regulations regarding disposal of the appliance for its flammable refrigerant and blowing gas. Before you scrap the appliance, please take off the doors to prevent children trapped.
- 10) This appliance is intended to be used in household and similar applications such as
  - staff kitchen areas in shops, offices and other working environments;
  - farm houses and by clients in hotels, motels and other residential type environments;
  - bed and breakfast type environments;
  - catering and similar non-retail applications.
- 11) Do not store explosive substances such as aerosol cans with a flammable propellant in this appliance.



IT IS HAZARDOUS FOR ANYONE OTHER THAN AUTHORISED SERVICE PERSONNEL TO CARRY OUT SERVICING OF REPAIRS WHICH INVOLVE THE REMOVAL OF COVERS.



TO AVOID THE RISK OF AN ELECTRICAL SHOCK DO NOT ATTEMPT REPAIRS YOURSELF.

## 2. INSTALLTION

### 2.1 Location

When selecting a position for your unit you should make sure the floor is flat and firm, and the room is well ventilated. Avoid locating your unit near a heat source, e.g. cooker, boiler or radiator. Also avoid direct sunlight as it may increase the electrical consumption. Extreme cold ambient temperatures may also cause the unit not to perform properly. This unit is not designed for use in a garage or outdoor installation. Do not drape the unit with any covering.

When installing the unit, ensure that 10 cm of free space is left at both sides, 10 cm at the rear and 30 cm at the top of the unit. This will allow cold air to circulate **around the unit** and improve the efficiency of the cooling process.

### 2.2 Reversing the Door Swing

**Tools Required:** Phillips style screwdriver / **Flat-blade screwdriver**/ Hexagonal spanner/  
**Hexagonal socket wrench**

- 1) Remove the right top **hinge cover**.

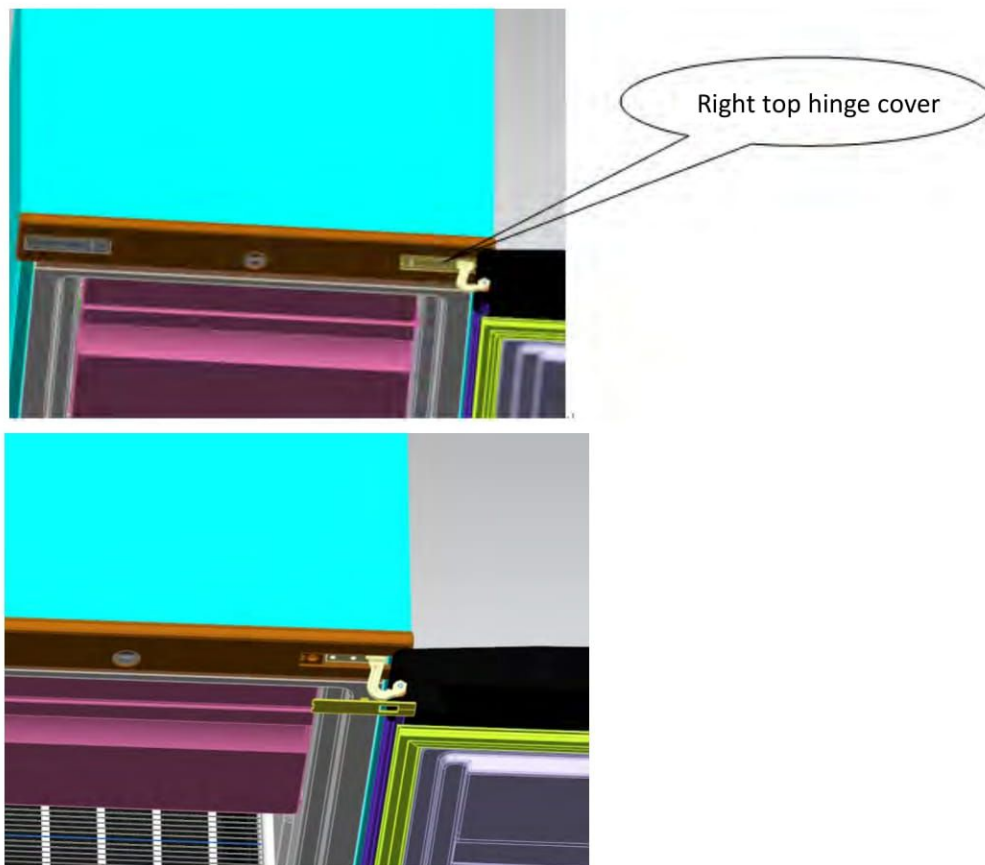

- 2) Remove the screws fixed the top-hinge with cross-slot screwdriver.

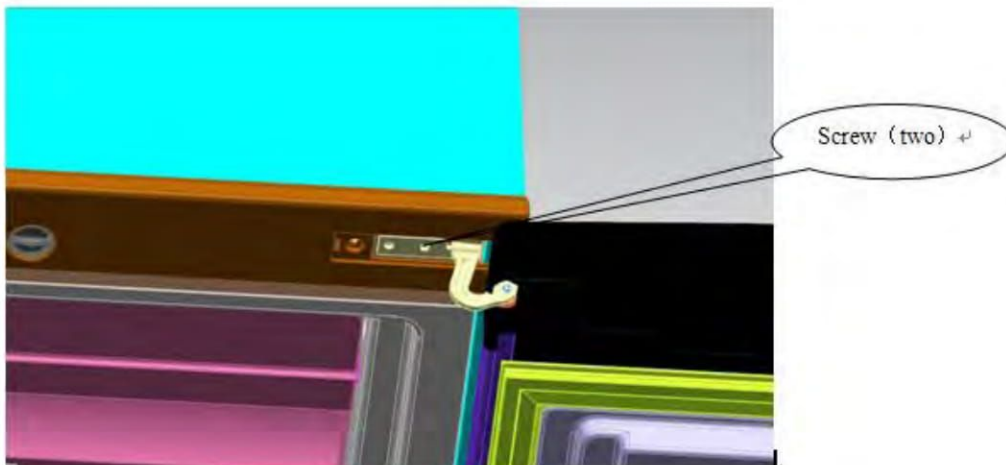

- 3) Replace the top-hinge and the top-door limit block and the door bearing bush to the other side.

- A. Remove the nut with sleeve. Take off the washer then remove the axes to the other side and fixed.

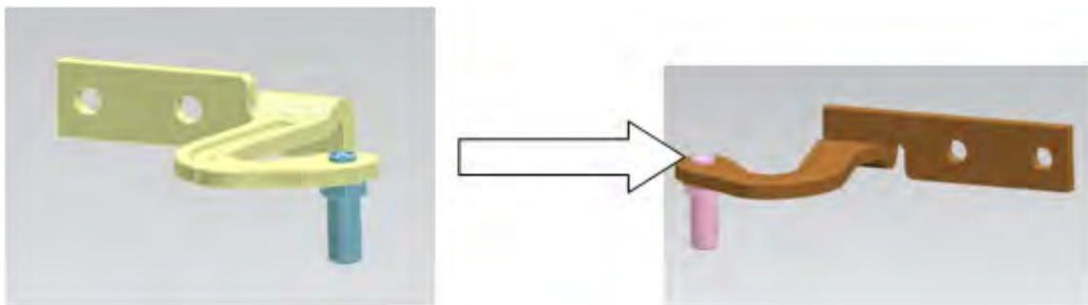

- B. Remove the door limit block

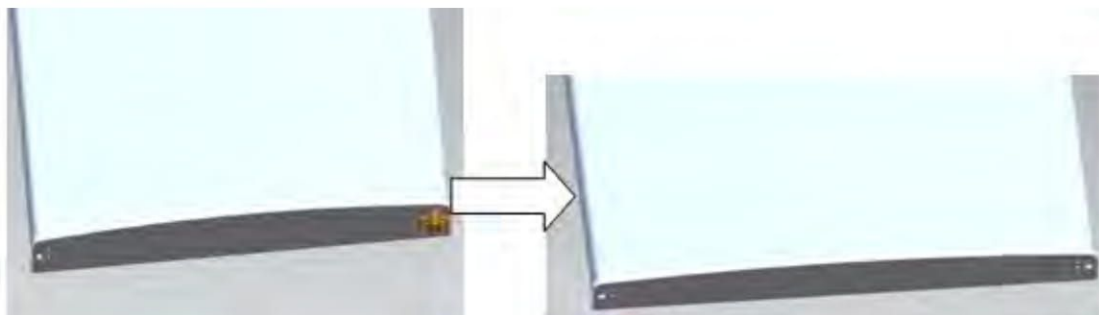

- C. Please taking out another door limit block, with screw mounting to the door



- 4) Disassemble the screws fixed the bottom-hinge with **Hexagonal socket wrench**.

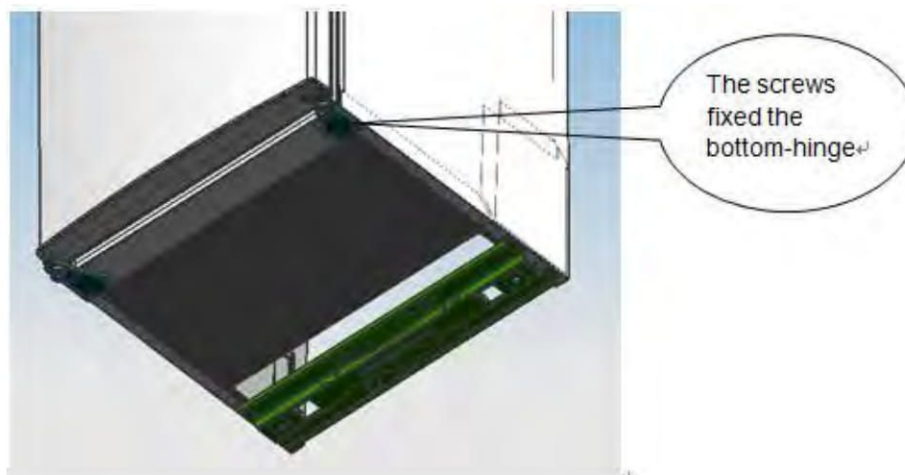

Note: the refrigerator-freezer incline angle less  $45^{\circ}$  .

- 5) Replace the bottom hinge to the other side then fix it with screws.

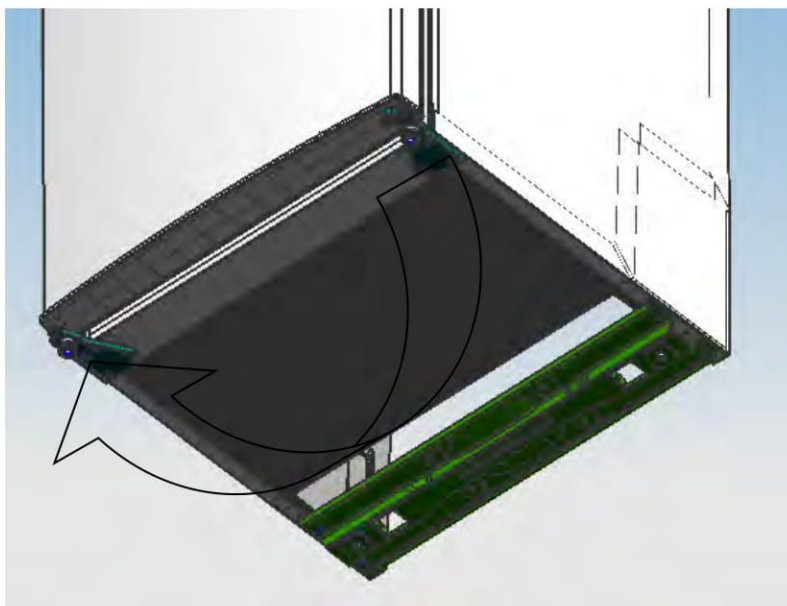

- 6) Set the door right position,fix the mid-hinge.

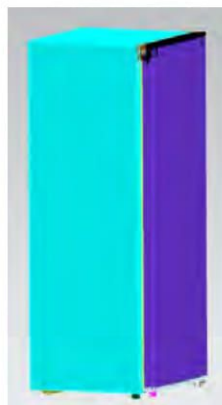

7) Replace the top-hinge.

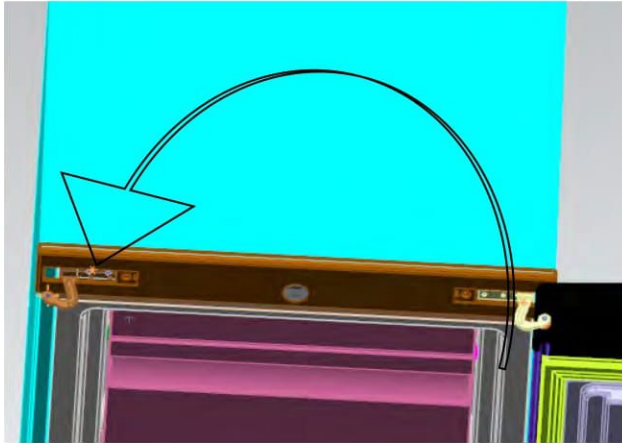

8) Set the top door right position, fix the top-hinge and the cover.

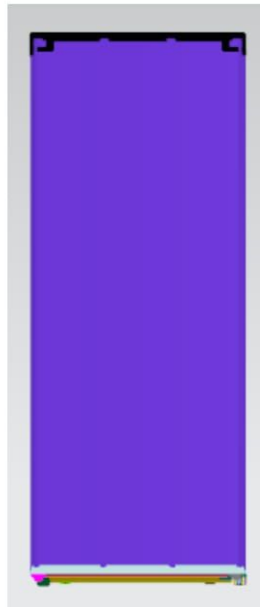

9) Replace the leveler to the other side and adjust it to make sure the cabinet level.



## 2.3 Door Space Requirements

The unit's door must be able to open fully as shown.

$W \times D \geq 902 \times 1052 \text{mm}$

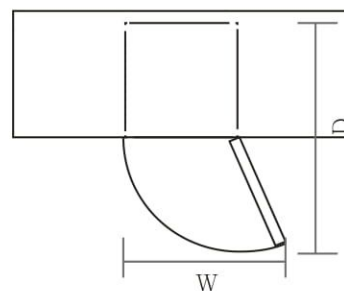

## 2.4 Levelling the Unit

To do this adjust the two levelling feet at the front of the unit.

If the unit is not level, the door and magnetic seal alignments will not be covered properly.

Make sure that the foot touches the ground before use.

Look down from the top, clockwise and counterclockwise loosening, tightening.

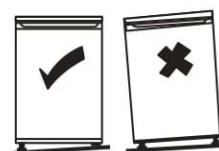

## 2.5 Cleaning Before Use

Wipe the inside of the unit with a weak solution of bicarbonate soda. Then rinse with warm water using a 'Wrung-out' sponge or cloth. Wash the shelves and salad bin in warm soapy water and dry completely before replacing in the unit. Clean the exterior of the unit with a damp cloth. If you require more information refer to the Cleaning section.

## 2.6 Before Using Your Unit

Do not damage the power cord under any condition so as to ensure safety use, do not use when the power cord is damaged or the plug is worn.

Do not put flammable, explosive, volatile and highly corrosive items in the refrigerator to prevent damages to the product or fire accidents.

Do not place flammable items near the refrigerator to avoid fires.

This product is household refrigerators and shall be only suitable for the storage of foods. According to national standards, household refrigerators shall not be used for other purposes, such as storage of blood, drugs or biological products.

Do not place items such as bottled or sealed container of fluid such as bottled beers and beverages in the freezer to prevent bursts and other losses.

Before placing any food in your unit, turn it on and wait for 24 hours, to make sure it is working properly and to allow it time to fall to the correct temperature. Your unit should not be overfilled.



### ◆ Before Plugging in

You must check that you have a socket which is compatible with the plug supplied with the unit.

### ◆ Before Turning On!

Do not turn on until two hours after moving the unit.



## 2.7 Interior Accessories

Various glass or plastic storage shelves are included with your appliance - different models have different combinations.

You should always slide one of the full size glass storage shelves into the lowest set of guides, above the fruit and vegetable containers, and keep it in this position. To do this, pull the storage shelf forward until it can be swivelled upwards or downwards and removed.

Please do the same in reverse to insert the shelf at a different height.

 In order to make the most of the volume of the fresh food storage compartment and frozen-food storage compartment, the user can remove one or more shelves, drawers, out of the appliance, according to your daily use.

## 3. PRODUCT OVERVIEW

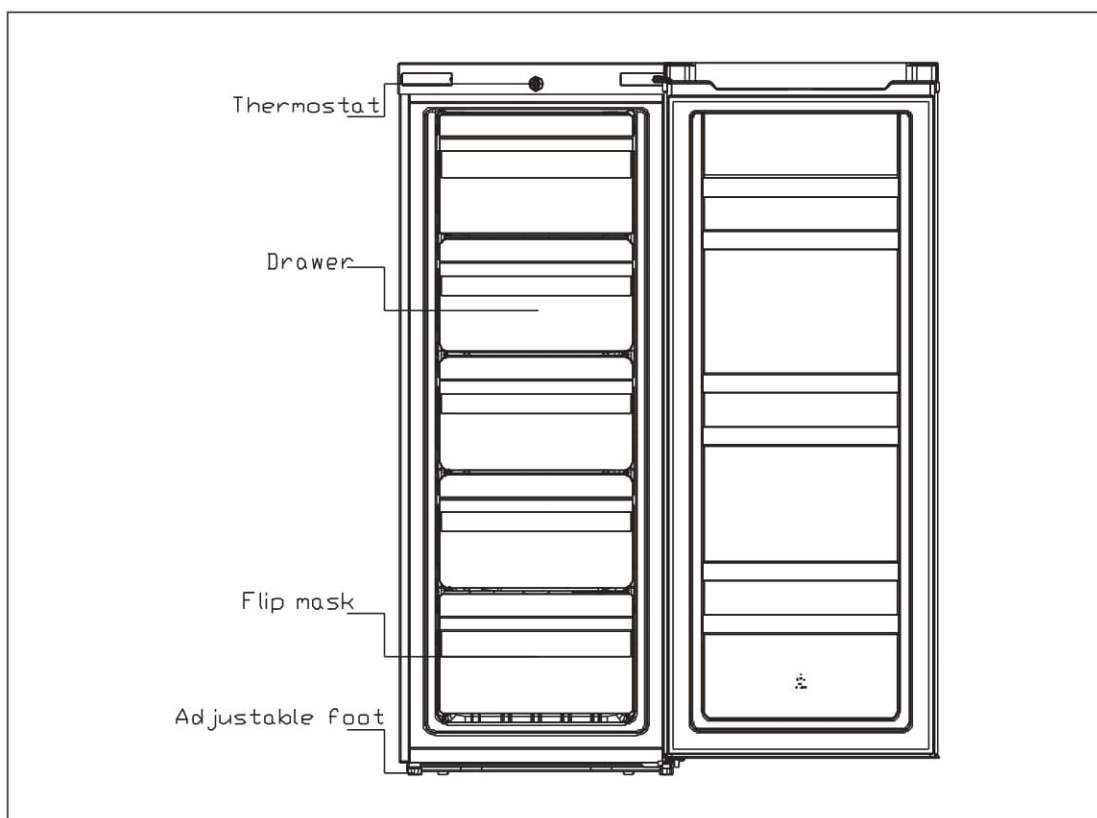

\*All images in this instruction manual are for indication only; please refer to your individual unit for details.

## 4. OPERATION

### 4.1 Switching On Your Unit

◆ The temperature selector knob is **located on the middle of the upper beam**

Setting “Min”: Less Cool Temperature

Setting “Med”: Normal Operation (adequate for most situations)

Setting “Max”: Coolest Temperature

◆ During high ambient temperatures e.g. on hot summer days. It may be necessary to set the thermostat to the Coolest setting (position “Max”). This may cause the compressor running continuously in order to maintain a low temperature in the cabinet.

◆ For the first time you install your refrigerator, set the thermostat knob at “Med”.

Give your refrigerator time to cool down completely before adding food. It is the best to wait 24 hours before adding food. The thermostat knob controls the temperature.

### 4.2 Noise Inside the Unit!

You may notice that your unit makes some unusual noises. Most of these are perfectly normal, but you should be aware of them!

These noises are caused by the circulation of the refrigerant liquid in the cooling system. It has become more pronounced since the introduction of CFC free gases. This is not a fault and will not affect the performance of your unit. This is the compressor motor working, as it pumps the refrigerant around the system.

### 4.3 Tips for Keeping Food in the Unit

- ◆ Cooked meats/fishes should always be stored on a shelf above raw meats/fishes to avoid bacterial transfer. Keep raw meats/fishes in a container which is large enough to collect juices and cover it properly. Place the container on the lowest shelf.
- ◆ Leave space around your food, to allow air to circulate inside the unit. Ensure all parts of the unit are kept cool.
- ◆ To prevent transfer of flavours and drying out, pack or cover the food separately. Fruit and vegetables do not need to be wrapped.
- ◆ Always let pre-cooked food cool down before you put in the unit. This will help to maintain the internal temperature of the unit.
- ◆ To prevent cold air escaping from the unit, try to limit the number of times you open the door. We recommend that you only open the door when you need to put food in or take food out.

## 5. CLEANING

### 5.1 Defrosting

Auto-defrost for Frost-free Refrigerator

### 5.2 Cleaning the Interior and the Exterior of the Unit

- ◆ Remove all the shelves and the salad bin. To remove the salad bin first remove the lower door shelf.
- ◆ Wipe the inside of the unit with a weak solution of bicarbonate soda and then rinse with warm water using a “wrung-out” sponge or cloth. Wipe completely dry before replacing the shelves and salad bin.
- ◆ Use a damp cloth to clean the exterior, and then wipe with a standard furniture polish. Make sure that the door is closed to avoid the polish getting on the magnetic door seal or inside the unit.
- ◆ The grille of the condenser at the back of the unit and the adjacent components can be vacuumed using a soft brush attachment.

### 5.3 Cleaning Tips

Condensation may appear on the outside of the unit. This may be due to a change in room temperature. Wipe off any moisture residue. If the problem continues, please contact a qualified technician for assistance.

## 6. MAINTENANCE

### 6.1 Care When Handling / Moving Your Unit

Hold the unit around its sides or base when moving it. Under no circumstances should it be lifted by holding the edges of the top surface.

### 6.2 Servicing

The unit should be serviced by an authorized engineer and only genuine spare parts should be used. Under no circumstances should you attempt to repair the unit yourself. Repairs carried out by inexperienced persons may cause injury or serious malfunction. Contact a qualified technician.

### 6.3 Switching Off for Long Periods of Time

When the unit is not in use for a long period of time, disconnect it from the mains supply, empty all food and clean the appliance, leaving the door ajar to prevent unpleasant smells.

## 7. Trouble shooting

The following simple issues can be handled by the user. Please call the after-sale service department if the issues are not settled.

Inoperation	Whether the freezer is plugged and connected to power; Low voltage; Failure power or tripping circuit
Odor	Odorous foods should closely wrapped; Whether foods are rotten; Whether the interior shall be cleaned.
Long-term operation of compressor	It is normal that refrigerator operates for longer time in summer when the ambient temperature is higher; Do not put too much food in the freezer at one time; Do not put foods until they are cooled; Frequent opening of refrigerator door.
Illuminating light does not shine	Whether the refrigerator is connected to power, whether the illuminating light is damaged.
The refrigerator door can not be properly closed.	The freezer door is stuck by food packages; Too much food; Tilt refrigerator.
Loud noises	Whether the food is leveled, whether the refrigerator is balanced; Whether the refrigerator parts are properly placed.

### 7.1 Warm tips:

- ◆The refrigerator enclosure may emit heat during operation specially in summer, this is caused by the radiation of the condenser, and it is a normal phenomenon.
- ◆Condensation: condensation phenomenon will be detected on the exterior surface and door seals of the freezer when the ambient humidity is large, this is a normal phenomenon, and the condensation can be wiped away with a dry towel.
- ◆Buzz: Buzz will be generated by running compressor specially when starting up or shutting down.

## 8. TIPS FOR ENERGY SAVING

Try not to open the door too often, especially when the weather is wet and hot. Once you open the door, close it as soon as possible.

Every now and then check if the appliance is sufficiently ventilated (adequate air circulation behind the appliance).

In normal temperature conditions, please arrange the thermostat at the middle setting.

Before loading the appliance with packages of fresh food, make sure they are cooled to ambient temperature.

Ice and frost layer increase energy consumption, so clean the appliance as soon as the layer is 3-5 mm thick.

If it is the outer condenser, the rear wall should be always clean free of dust or any impurities.

- ◆ The appliance should be located in the coolest area of the room, away from heat producing appliances or heating ducts, and out of the direct sunlight.
- ◆ Let hot foods cool to room temperature before placing in the appliance. Overloading the appliance forces the compressor to run longer. Foods that freeze too slowly may lose quality, or spoil.
- ◆ Be sure to wrap foods properly, and wipe containers dry before placing them in the appliance. This cuts down on frost build-up inside the appliance.
- ◆ Appliance storage bin should not be lined with aluminum foil, wax paper, or paper toweling. Liners interfere with cold air circulation, making the appliance less efficient.
- ◆ Organize and label food to reduce door openings and extended searches. Remove as many items as needed at one time, and close the door as soon as possible.

## 9. DISPOSAL

Old units still have some residual value. An environmentally friendly method of disposal will ensure that valuable raw materials can be recovered and used again. The refrigerant used in your unit and insulation materials require special disposal procedures. Ensure that none of the pipes on the back of the unit are damaged prior to disposal. Up to date information concerning options of disposing of your old unit and packaging from the new one can be obtained from your local council office.

When disposing of an old unit break of any old locks or latches and remove the door as a safeguard.

Correct Disposal of this product	
	<p>Correct Disposal of this product</p> <p>This marking indicates that this product should not be disposed with other household wastes throughout the EU. To prevent possible harm to the environment or human health from uncontrolled waste disposal, recycle it responsibly to promote the sustainable reuse of material resources. To return your used device, please use the return and collection systems or contact the retailer where the product was purchased. They can take this product for environmental safe recycling.</p>

For more information, please contact the local authority or your retailer where you purchased the product.